



# Spectral M800 IP67

ORDERCODE 43501



**SHOWELECTRONICS FOR PROFESSIONALS**

## **Congratulations!**

You have bought a great, innovative product from Showtec.

The Showtec Spectral M800 brings excitement to any venue. Whether you want simple plug-&-play action or a sophisticated DMX show, this product provides the effect you need.

You can rely on Showtec, for more excellent lighting products.

We design and manufacture professional light equipment for the entertainment industry.

New products are being launched regularly. We work hard to keep you, our customer, satisfied.

For more information: [iwant@showtec.info](mailto:iwant@showtec.info)

You can get some of the best quality, best priced products on the market from Showtec.

So next time, turn to Showtec for more great lighting equipment.

Always get the best -- with Showtec !

Thank you!



|   |    |
|---|----|
| <b>Warning</b> .....  | 2  |
| Safety-instructions.....                                    | 2  |
| Operating Determinations.....                               | 3  |
| Rigging.....  | 4  |
| Return Procedure.....                                       | 5  |
| Claims.....   | 5  |
| <b>Description</b> .....                                    | 6  |
| Features.....   | 6  |
| DMX Channel Summary.....                                    | 7  |
| Overview.....   | 8  |
| Backside.....   | 8  |
| <b>Installation</b> .....                                   | 9  |
| <b>Set Up and Operation</b> .....                           | 9  |
| Fixture Linking.....  | 9  |
| Data Cabling.....   | 9  |
| Control Panel.....  | 11 |
| DMX Addressing without ID addressing.....                   | 11 |
| DMX Addressing with ID Address.....                         | 12 |
| MENU OVERVIEW .....   | 13 |
| - Creating a static color .....                             | 14 |
| - Activating an Auto Program .....                          | 15 |
| - Run Mode.....   | 16 |
| - DMX 512 Address.....                                      | 16 |
| - Personality.....  | 16 |
| - ID Address.....   | 16 |
| - Edit Custom.....  | 17 |
| - Changing the Settings.....                                | 17 |
| - White Settings.....                                       | 18 |
| - White Balance.....  | 19 |
| - Activating the Password .....                             | 19 |
| <b>How to make your own Custom Program</b> .....            | 20 |
| <b>Modes</b> .....  | 21 |
| 10-channel ( <b>TOUR</b> ) .....                            | 21 |
| 3-channel ( <b>ARC.1</b> ): RGB.....                        | 23 |
| 4-channel ( <b>AR1.d</b> ): Master Dimmer, RGB.....         | 23 |
| 5-channel ( <b>AR1.s</b> ): Master Dimmer, RGB, Strobe..... | 23 |
| 3-channel ( <b>HSV</b> ): Hue, Saturation, Value.....       | 23 |
| <b>DMX Value – ID Addresses</b> .....                       | 24 |
| <b>Beam Angles</b> .....                                    | 25 |
| <b>Connection Cables</b> .....                              | 26 |
| <b>Maintenance</b> .....                                    | 26 |
| <b>Troubleshooting</b> .....                                | 26 |
| <b>Product Specifications</b> .....                         | 27 |

# WARNING

**FOR YOUR OWN SAFETY, PLEASE READ THIS USER MANUAL CAREFULLY  
BEFORE YOUR INITIAL START-UP!**

## Unpacking Instructions

Immediately upon receiving this product, carefully unpack the carton and check the contents to ensure that all parts are present, and have been received in good condition. Notify the dealer immediately and retain packing material for inspection if any parts appear damaged from shipping or the carton itself shows signs of mishandling. Save the carton and all packing materials. In the event that a fixture must be returned to the factory, it is important that the fixture be returned in the original factory box and packing.

### Your shipment includes:

- Spectral M800 IP67
- 1X Special Powercable 1,5m.
- 1X special 3-pin to DMX IN (3-pin)
- 1X special 3-pin to DMX OUT (3-pin)
- 1X special mounting plate
- 2X Endcap
- User manual





## LED Expected Lifespan

LEDs gradually decline in brightness over time. HEAT is the dominant factor that leads to the acceleration of this decline. Packaged in clusters, LEDs exhibit higher operating temperatures than in ideal or singular optimum conditions. For this reason when all color LEDs are used at their fullest intensity, life of the LEDs is significantly reduced. It is estimated that a viable lifespan of 40,000 to 50,000 hours will be achieved under normal operational conditions. If improving on this lifespan expectancy is of a higher priority, place care in providing for lower operational temperatures. This may include climatic-environmental and the reduction of overall projection intensity.

## SAFETY INSTRUCTIONS

Every person involved with the installation, operation and maintenance of this device has to:

- be qualified
- follow the instructions of this manual

 **CAUTION! Be careful with your operations.  
With a dangerous voltage you can suffer  
a dangerous electric shock when touching the wires!** 

Before your initial start-up, please make sure that there is no damage caused by transportation. Should there be any, consult your dealer and do not use the device.

To maintain perfect condition and to ensure a safe operation, it is absolutely necessary for the user to follow the safety instructions and warning notes written in this manual.

Please consider that damages caused by manual modifications to the device are not subject to warranty.

This device contains no user-serviceable parts. Refer servicing to qualified technicians only.

### IMPORTANT:

*The manufacturer will not accept liability for any resulting damages caused by the non-observance of this manual or any unauthorized modification to the device.*

- Never let the power-cord come into contact with other cables! Handle the power-cord and all connections with the mains with particular caution!
- Never remove warning or informative labels from the unit.
- Never use anything to cover the ground contact.
- Never look directly into the light source.
- Never leave any cables lying around.
- Never use the device during thunderstorms, unplug the device immediately.
- Never leave various parts of the packaging (plastic bags, polystyrene foam, nails, etc.) within children's reach, as they are potential sources of danger.
- Do not insert objects into air vents.
- Do not open the device and do not modify the device.
- Do not connect this device to a dimmerpack.
- Do not shake the device. Avoid brute force when installing or operating the device.
- Do not switch the device on and off in short intervals, as this would reduce the system's life.
- Only use device indoor, avoid contact with water or other liquids.
- Only operate the device after having familiarized with its functions.
- Avoid flames and do not put close to flammable liquids or gases.
- Always allow free air space of at least 50 cm around the unit for ventilation.
- Always disconnect power from the mains, when device is not used or before cleaning! Only handle the power-cord by the plug. Never pull out the plug by tugging the power-cord.
- Make sure that the device is not exposed to extreme heat, moisture or dust.
- Make sure that the available voltage is not higher than stated on the rear panel.
- Make sure that the power-cord is never crimped or damaged. Check the device and the power-cord from time to time.
- Make sure that no side forces can impact on the truss system.
- The cable insert or the female part in the device must never be strained. There must always be sufficient cable to the device. Otherwise, the cable may be damaged which may lead to deadly electrical shocks.
- If the external cable is damaged, it has to be replaced by a qualified technician.
- If the lens is obviously damaged, it has to be replaced. So that its functions are not impaired, due to cracks or deep scratches.
- If device is dropped or struck, disconnect mains power supply immediately. Have a qualified engineer inspect for safety before operating.
- If the device has been exposed to drastic temperature fluctuation (e.g. after transportation), do not switch it on immediately. The arising condensation water might damage your device. Leave the device switched off until it has reached room temperature.
- If your Showtec device fails to work properly, discontinue use immediately. Pack the unit securely (preferably in the original packing material), and return it to your Showtec dealer for service.
- For adult use only. The device must be installed out of the reach of children. Never leave the unit running unattended.
- For replacement use fuses of same type and rating only.
- The user is responsible for correct positioning and operating of the Spectral M800. The manufacturer will not accept liability for damages caused by the misuse or incorrect installation of this device.
- This device falls under protection class I. Therefore it is essential to connect the yellow/green conductor to earth.
- Repairs, servicing and electric connection must be carried out by a qualified technician.
- WARRANTY: Till one year after date of purchase.



**CAUTION ! EYEDAMAGES !**  
**Avoid looking directly into the light source.**  
**(meant especially for epileptics) !**



## OPERATING DETERMINATIONS

This device is not designed for permanent operation. Consistent operation breaks will ensure that the device will serve you for a long time without defects.

The minimum distance between light-output and the illuminated surface must be more than 1.5 meter.

The maximum ambient temperature  $t_a = 45^\circ\text{C}$  must never be exceeded.

The relative humidity must not exceed 50 % with an ambient temperature of  $45^\circ\text{C}$ .

If this device is operated in any other way, than the one described in this manual, the product may suffer damages and the warranty becomes void.

Any other operation may lead to dangers like short-circuit, burns, electric shock, lamp explosion, crash etc.

You endanger your own safety and the safety of others!

*Improper installation can cause serious damage to people and property !*

### Rigging

*Please follow the European and national guidelines concerning rigging, trussing and all other safety issues.*

*Do not attempt the installation yourself !*

*Always let the installation be carried out by an authorized dealer !*

### Procedure:

- If the Spectral M800 is lowered from the ceiling or high joists, professional trussing systems have to be used.
- Use a clamp to mount the Spectral M800, with the mounting-bracket, to the trussing system.
- The Spectral M800 must never be fixed swinging freely in the room.
- The installation must always be secured with a safety attachment, e.g. an appropriate safety net or safety-cable.
- When rigging, derigging or servicing the Spectral M800, always make sure, that the area below the installation place is blocked and staying in the area is forbidden.

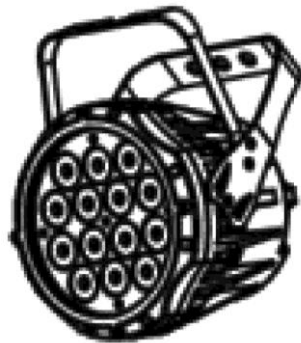

The Spectral M800 can be mounted in a hanging position (Fig. Above) or Upright (Fig. Below), using the support brackets. Mounting the Spectral M800 with a clamp or any other mounting bracket is recommended, depending on the requirements of your application.

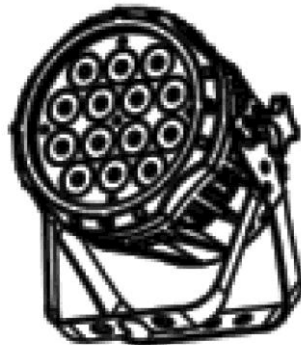

The Spectral M800 can be placed on a flat stage floor or mounted to any kind of truss by a clamp.

*Improper installation can cause serious damage to people and property !*

## Connection with the mains

Connect the device to the mains with the power-plug.

Always pay attention, that the right color cable is connected to the right place.

| International   | EU Cable     | UK Cable | US Cable      | Pin   |
|---|--------------|----------|---------------|-------|
| L   | BROWN        | RED      | YELLOW/COPPER | FASE  |
| N   | BLUE         | BLACK    | SILVER        | NUL   |
|  | YELLOW/GREEN | GREEN    | GREEN         | EARTH |

Make sure that the device is always connected properly to the earth!

## Return Procedure

Returned merchandise must be sent prepaid and in the original packing, call tags will not be issued. Package must be clearly labeled with a Return Authorization Number (RMA number). Products returned without an RMA number will be refused. Highlite will not accept the returned goods or any responsibility. Call Highlite 0031-455667723 or mail [offersales@highlite.nl](mailto:offersales@highlite.nl) and request an RMA prior to shipping the fixture. Be prepared to provide the model number, serial number and a brief description of the cause for the return. Be sure to properly pack fixture, any shipping damage resulting from inadequate packaging is the customer's responsibility. Highlite reserves the right to use its own discretion to repair or replace product(s). As a suggestion, proper UPS packing or double-boxing is always a safe method to use.

**Note: If you are given an RMA number, please include the following information on a piece of paper inside the box:**

- 1) Your name
- 2) Your address
- 3) Your phone number
- 4) A brief description of the symptoms

## Claims

The client has the obligation to check the delivered goods immediately upon delivery for any shortcomings and/or visible defects, or perform this check after our announcement that the goods are at their disposal. Damage incurred in shipping is the responsibility of the shipper; therefore the damage must be reported to the carrier upon receipt of merchandise.

It is the customer's responsibility to notify and submit claims with the shipper in the event that a fixture is damaged due to shipping. Transportation damage has to be reported to us within one day after receipt of the delivery.

Any return shipment has to be made post-paid at all times. Return shipments must be accompanied with a letter defining the reason for return shipment. Non-prepaid return shipments will be refused, unless otherwise agreed in writing.

Complaints against us must be made known in writing or by fax within 10 working days after receipt of the invoice. After this period complaints will not be handled anymore.

Complaints will only then be considered if the client has so far complied with all parts of the agreement, regardless of the agreement of which the obligation is resulting.

## Description of the device

### Features

The Spectral M800 is a compact indoor/outdoor LED fixture from Showtec with 14 high power LEDs

- 3, 3, 4, 5 or 10-channel LED wash light (with ID addressing)
- 5 different DMX Operating modes
- custom over-sized lenses allow the fixture to capture a greater amount of light and project an output of over 800 lm.
- RGB colour mixing with or without DMX controller
- Colour temperature presets (3,200 K ~ 10,000 K)
- Built-in automated programs via DMX
- Recall custom programs via DMX
- 14x 3W 3-in-1 RGB LEDs
- High light-output
- Road-proof housing
- Available as IP-67 version or Tour version
- No fans, low noise
- Max. distance: 25m
- Colour Range: 16.7 million additive RGB colours
- Drive current: 350mA
- Power consumption: 73W max. at full output
- On-board: Display for Auto and Custom control
- Control protocol: DMX 512
- Control personality: TOUR, ARC1, AR1.d, AR1.s, HSV
- Dimmer: 0-100%
- Strobe: 0-20Hz
- Housing: Die-cast aluminium, powder-coated finish
- Lens plate: Tempered glass
- Cooling: Convection
- Ingress Protection: IP67; suitable for indoor and outdoor applications
- Adjustable barndoors to direct output (optional)
- LED display with lock-out feature
- Beam angle: 16°
- Lux: 1600+ @ 2m
- Lumen: 800+
- Efficiency: 16.30 lm/W (RGB full on)
- Double-bracket yoke doubles as floor stand

NOTE: Knowledge of DMX is required to fully utilize this unit.



## DMX Channel Summary

| <b>TOUR</b> | <b>Channel</b> | <b>Description</b>     |
|-------------|----------------|------------------------|
|             | 1              | Master Dimmer          |
|             | 2              | Red                    |
|             | 3              | Green                  |
|             | 4              | Blue                   |
|             | 5              | Color Macro            |
|             | 6              | Strobe                 |
|             | 7              | Auto & Custom Programs |
|             | 8              | Auto Speed Adjustment  |
|             | 9              | Dimmer Speed           |
|             | 10             | ID Address Selection   |

| <b>Arc.1</b> | <b>Channel</b> | <b>Description</b> |
|--------------|----------------|--------------------|
|              | 1              | Red                |
|              | 2              | Green              |
|              | 3              | Blue               |

| <b>Ar1.d</b> | <b>Channel</b> | <b>Description</b> |
|--------------|----------------|--------------------|
|              | 1              | Master Dimmer      |
|              | 2              | Red                |
|              | 3              | Green              |
|              | 4              | Blue               |

| <b>Ar1.s</b> | <b>Channel</b> | <b>Description</b> |
|--------------|----------------|--------------------|
|              | 1              | Master Dimmer      |
|              | 2              | Red                |
|              | 3              | Green              |
|              | 4              | Blue               |
|              | 5              | Strobe             |

| <b>HSV</b> | <b>Channel</b> | <b>Description</b> |
|------------|----------------|--------------------|
|            | 1              | Hue                |
|            | 2              | Saturation         |
|            | 3              | Value              |

## Overview



Fig. 1

- 1) Mountingbracket for Truss mounting
- 2) 14x 3W 3-in-1 RGB LEDs

## Backside



Fig. 2

- 4) Power IN
- 5) DMX signal connector (IN)
- 6) Power OUT
- 7) DMX signal connector (OUT)

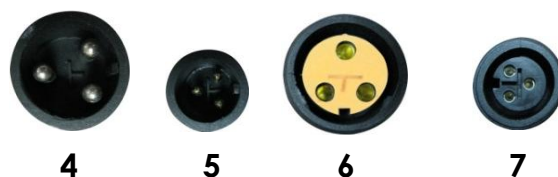

**Note:** You cannot plug a standard DMX cable directly into the connector  
Be sure to use the included special cable for DMX connection. 



**Female 3 pin DMX to special 3-pin Male**



**Male 3 pin DMX to special 3-pin Female**



**Powercable to special 3-pin Female**

## **Installation**

Remove all packing materials from the Spectral M800. Check that all foam and plastic padding is removed. Connect all cables.

**Do not supply power before the whole system is set up and connected properly.**  
**Always disconnect from electric mains power supply before cleaning or servicing.**  
**Damages caused by non-observance are not subject to warranty.**

## **Set Up and Operation**

Before plugging the unit in, always make sure that the power supply matches the product specification voltage. Do not attempt to operate a 120V specification product on 230V power, or vice versa.

## Fixture Linking

You will need a serial data link to run light shows of one or more fixtures using a DMX-512 controller or to run synchronized shows on two or more fixtures set to a master/slave operating mode. The combined number of channels required by all the fixtures on a serial data link determines the number of fixtures the data link can support.

The Spectral M800 uses a maximum of 10 channels.

**Important:** Fixtures on a serial data link must be daisy chained in one single line. To comply with the EIA-485 standard no more than 30 devices should be connected on one data link. Connecting more than 30 fixtures on one serial data link without the use of a DMX optically isolated splitter may result in deterioration of the digital DMX signal.



Maximum recommended DMX data link distance: 100 meters  
Maximum recommended number of LED Pars on a DMX data link: 30 fixtures  
@ 220V: 24 units may be connected in series  
@ 120V: 12 units may be connected in series

## Data Cabling

To link fixtures together you must obtain data cables. You can purchase DAP Audio certified DMX cables directly from a dealer/distributor or construct your own cable. If you choose to create your own cable please use data-grade cables that can carry a high quality signal and are less prone to electromagnetic interference.

### DAP Audio Certified DMX Data Cables

- DAP Audio Basic microphone cable for allround use. bal. XLR/M 3 p. > XLR/F 3 p.  
**Ordercode** FL01150 (1,5m.), FL013 (3m.), FL016 (6m.), FL0110 (10m.), FL0115 (15m.), FL0120 (20m.).
- DAP Audio cable for the demanding user with exceptional audio-qualities and connector made by Neutrik®. **Ordercode** FL71150 (1,5m.), FL713 (3m.), FL716 (6m.), FL7110 (10m.).



The Spectral M800 has a total of 5 DMX channel configurations, referred to as **Personalities**. The 5 personalities are [TOUR, ARC.1, AR1.d, AR1.s, HSV]. Each of the different personalities can be accessed from the control panel.

## Control Panel

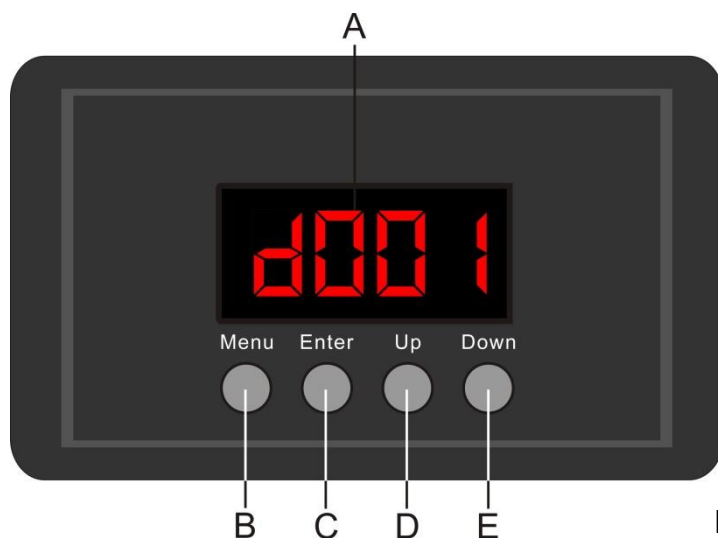
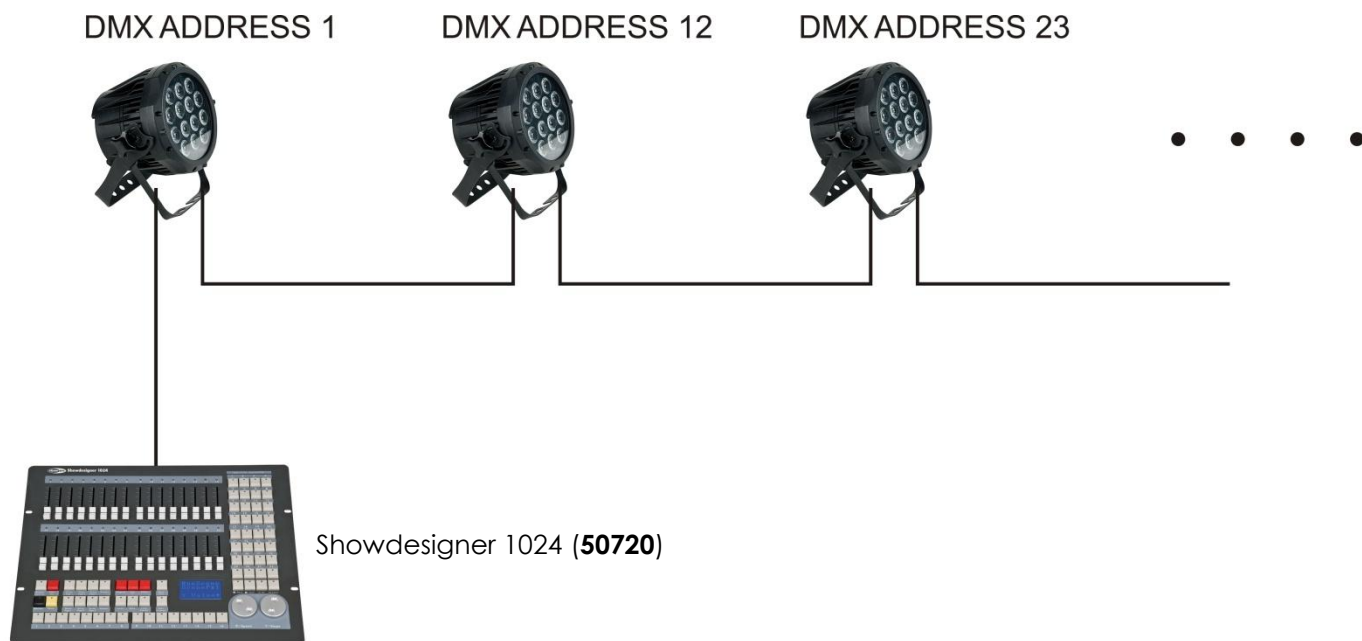

**Fig. 5**

- A. Display
- B. MENU Button
- C. ENTER Button
- D. Upn Button
- E. Down Button

## DMX512 ADDRESSING WITHOUT ID ADDRESSING

- 1) Connect a DMX controller (example 50720 Showdesigner 1024) to the series of Spectral M800's.
- 2) Each Spectral M800 has 10 DMX channels (DMX address LED Par #1=1, Par #2=11, Par #3=21, Par #4=31, etc.).
- 3) The ID address has not been set, so therefore when using the controller CH10 must be inactive (CH10=0). It is also possible to deactivate the ID address, by selecting ID OFF from the Settings menu.
- 4) Any DMX address in the range from 001 to 512 may be used.



Note: When using the Spectral M800's, the CH10 ID function must be inactive (CH10=0).

## DMX512 ADDRESSING WITH ID ADDRESS (TOUR MODE)

- 1) Connect a DMX controller (example 50720 Showdesigner 1024) to the series of Spectral M800's.
- 2) Each Spectral M800's has 10 DMX channels (DMX address LED Par #1=1, Par #2=11, Par #3=21, Par #4=31, etc.).
- 3) Any DMX address in the range from 001 to 512 may be used.
- 4) Each DMX address may carry up to 66 separate ID addresses.
- 5) The ID Address should be set in the SETTINGS menu, on each unit in ascending values (i.e. 1,2,3...).
- 6) ID On should be set in the SETTINGS menu on each unit.
- 7) ID addresses are accessible from CH10 on the DMX512 controller.

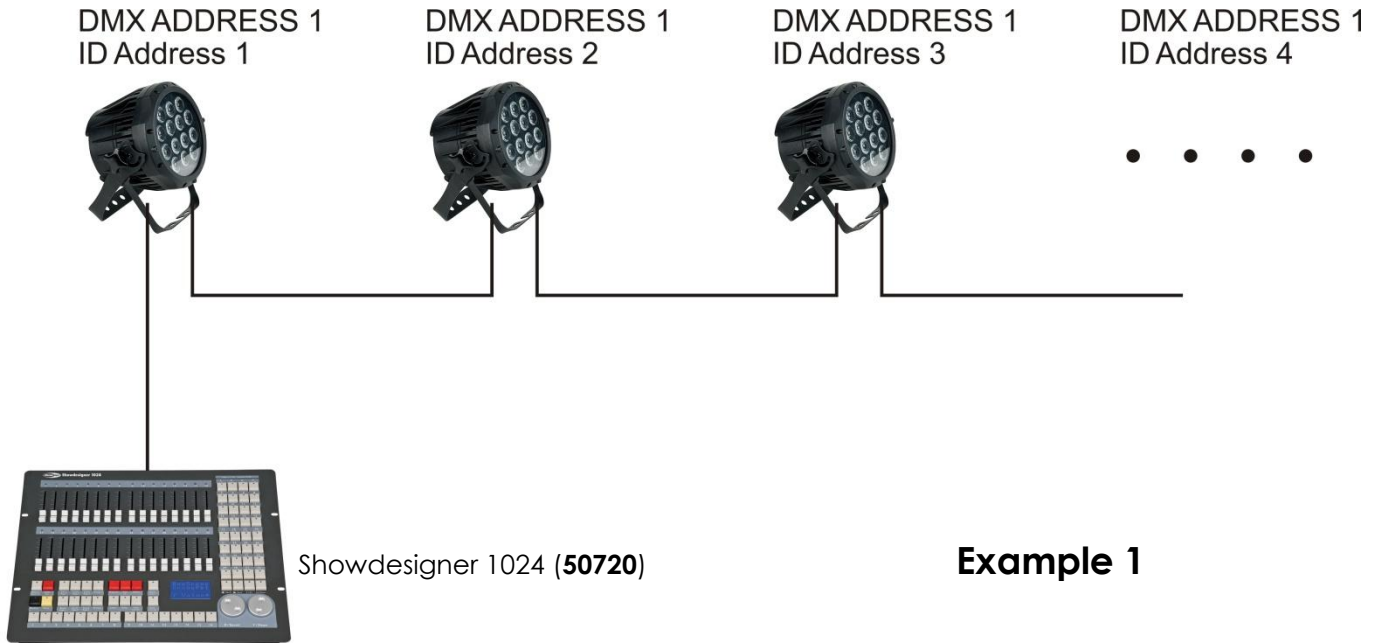

The figure above shows a simple DMX layout. All the Spectral M800's have different ID addresses which allows the user to collectively control the whole group of Spectral M800's with the same DMX address by setting CH10 to 0, or to control each Spectral M800 independently by first selecting the DMX address and then by using CH10 to locate the target ID address.

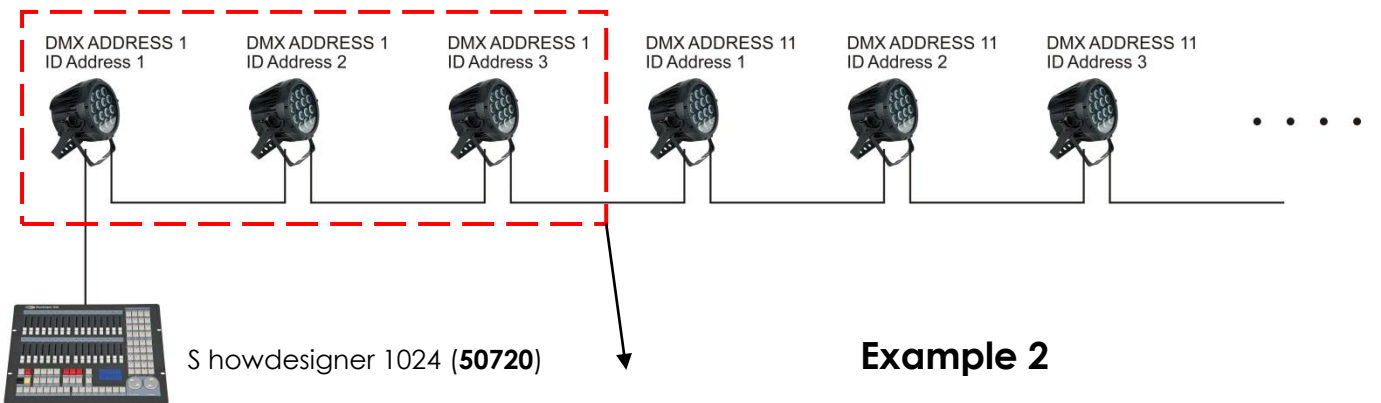

The figure above shows a simple DMX layout. All 3 Spectral M800's have different ID addresses, which allows the user to collectively control a group of 3 Spectral M800's with the same DMX address by setting CH10 to 0, or to control each Spectral M800 independently by first selecting the DMX address and then by using CH10 to locate the target ID address.

# MENU OVERVIEW

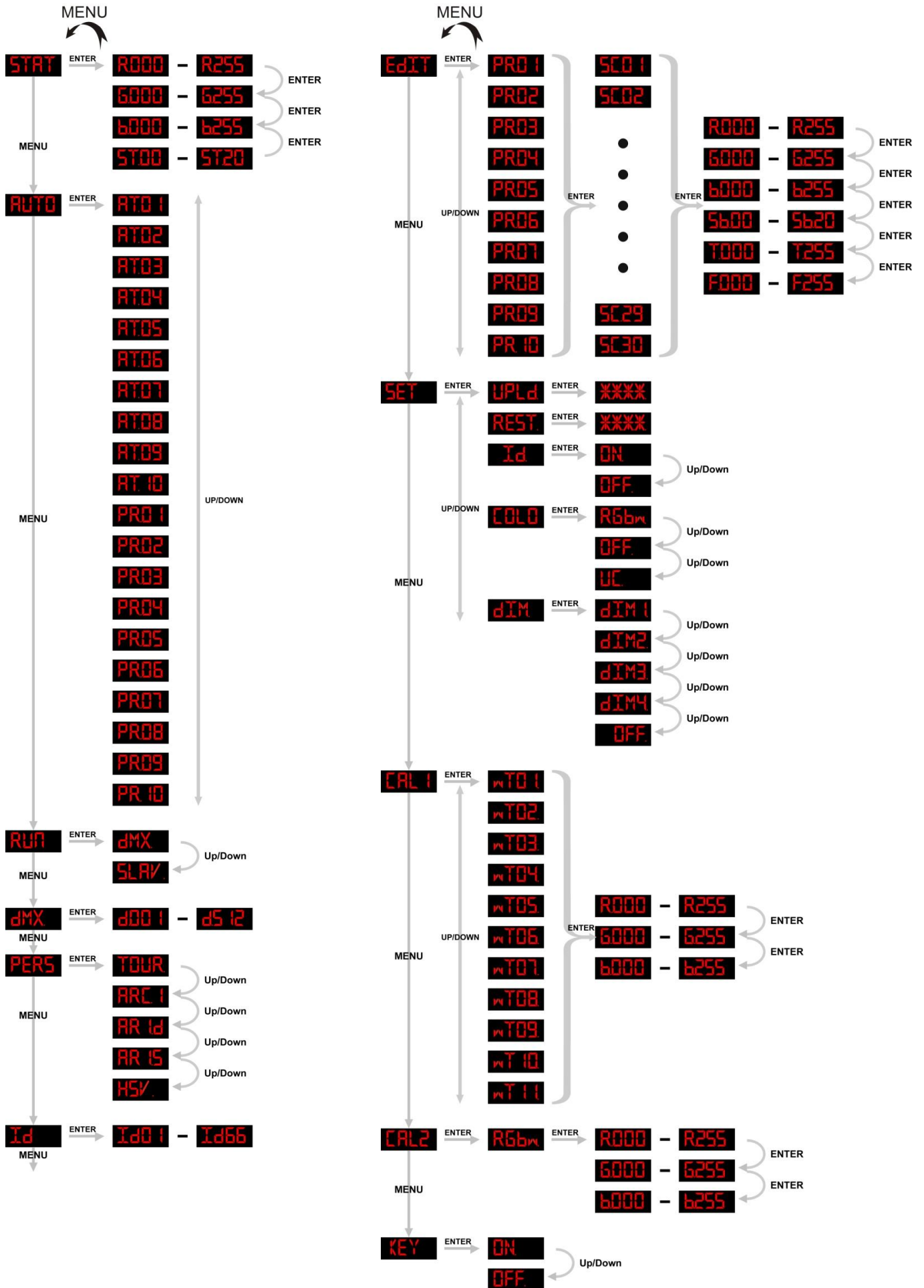

## Main Menu Options

Press the MODE button to scroll through 11 options of the menu:



## Creating a static color



When you press ENTER in menu Static color, you have to use ENTER to scroll through this menu. Use the UP/DOWN buttons to change the static colors (Red, Green, Blue) or the strobe speed (0-20Hz). Press MENU to go 1 step back. You can combine RED, GREEN and BLUE to create an infinite range of colors (0-255).

### Red

Set the value of the red LEDs (0-255).

### Strobe

Set the value of the flash (0-20Hz).

### Green

Set the value of the green LEDs (0-255).

### Blue

Set the value of the blue LEDs (0-255).



## Activating an Auto Program

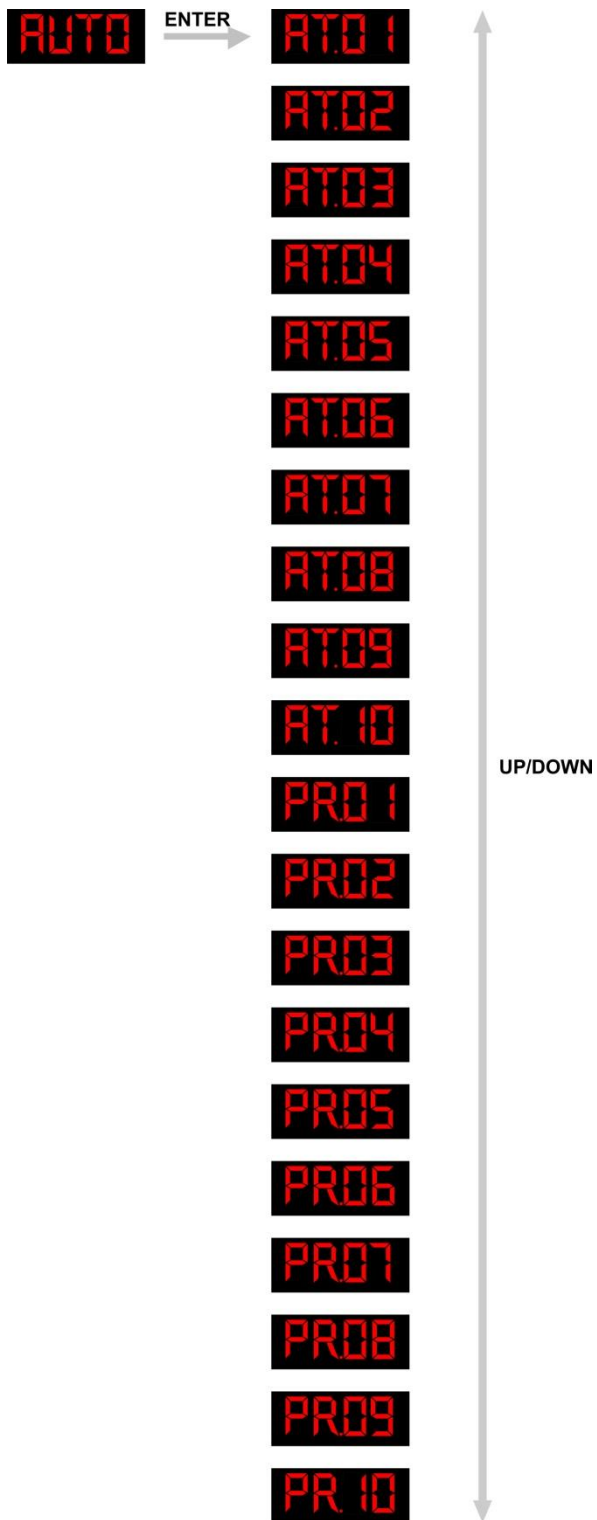

When you press ENTER in menu Auto Program, you can choose one of the 10 built-in programs. You can also edit 10 custom programs.

## Run Mode



- Enter the RUN MODE mode to set the desired working mode:
  - DMX mode is used when working with a DMX512 controller to control the LED Par.
  - SLAVE mode is for using the device during a Master-Slave operation.

⚠ When the fixtures are in Auto program operation, the RUN MODE does not work. ⚠

## DMX 512 Address



When you press ENTER in menu DMX 512 address you can set the DMX address. You can choose your DMX address between 0-512.

## Personality

Enter the PERSONALITY mode to select a DMX mode: TOUR, ARC1, AR1d, AR1s, HSV.

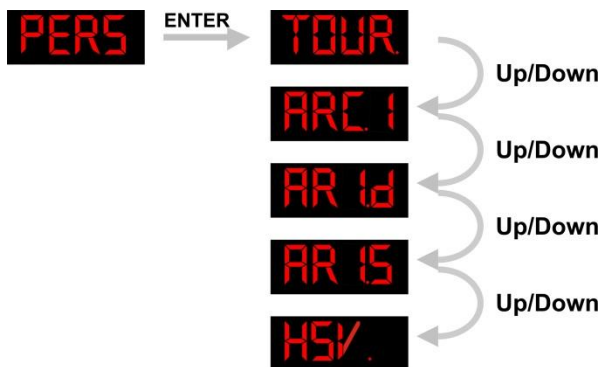

- TOUR:** 10 channels
- ARC1:** 3 channels
- AR1d:** 4 channels
- AR1s:** 5 channels
- HSV:** 3 channels

## ID Address



Enter the ID ADDRESS mode to set the desired ID ADDRESS; range ID1 – ID66.

## Edit Custom

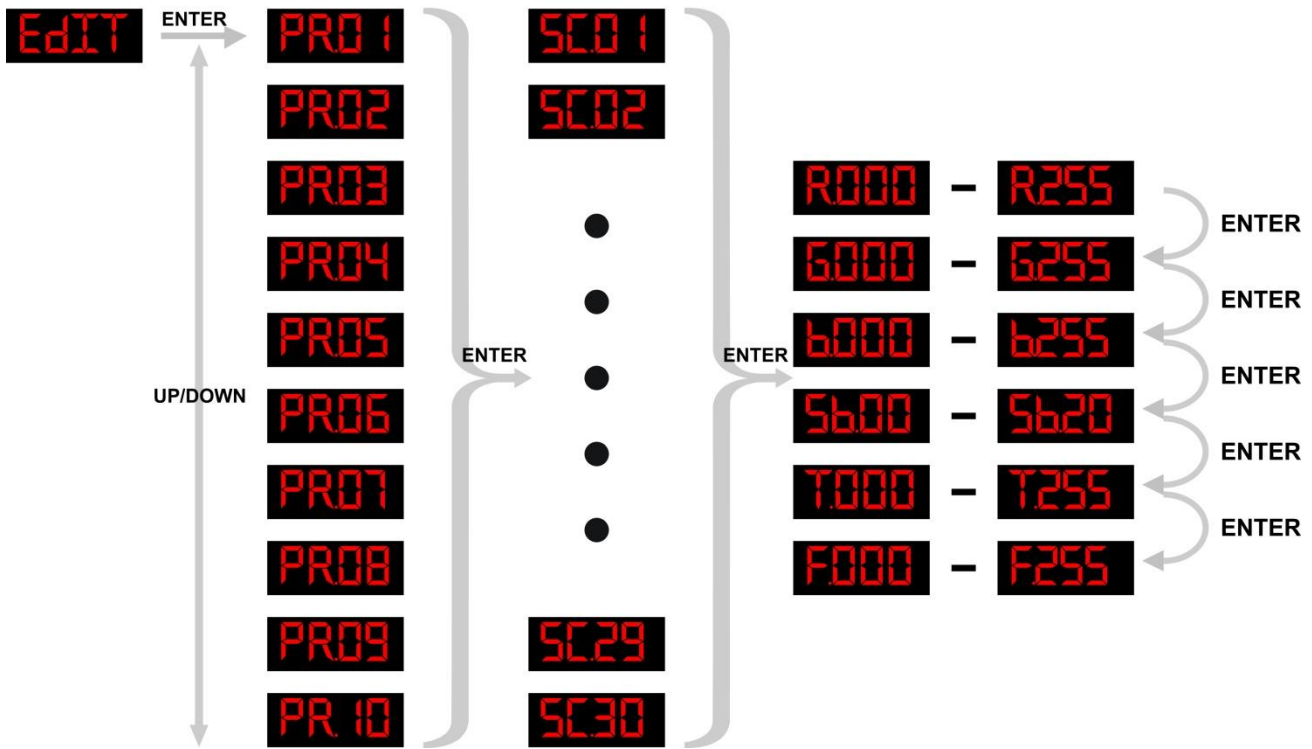

- Enter the EDIT CUSTOM mode to edit the custom programs PR01 – PR10.
- Each custom program has 30 steps, which can be edited.
- Each step allows the creation of a scene using RED, GREEN, BLUE, STROBE, TIMER & FADE.

## Changing the Settings

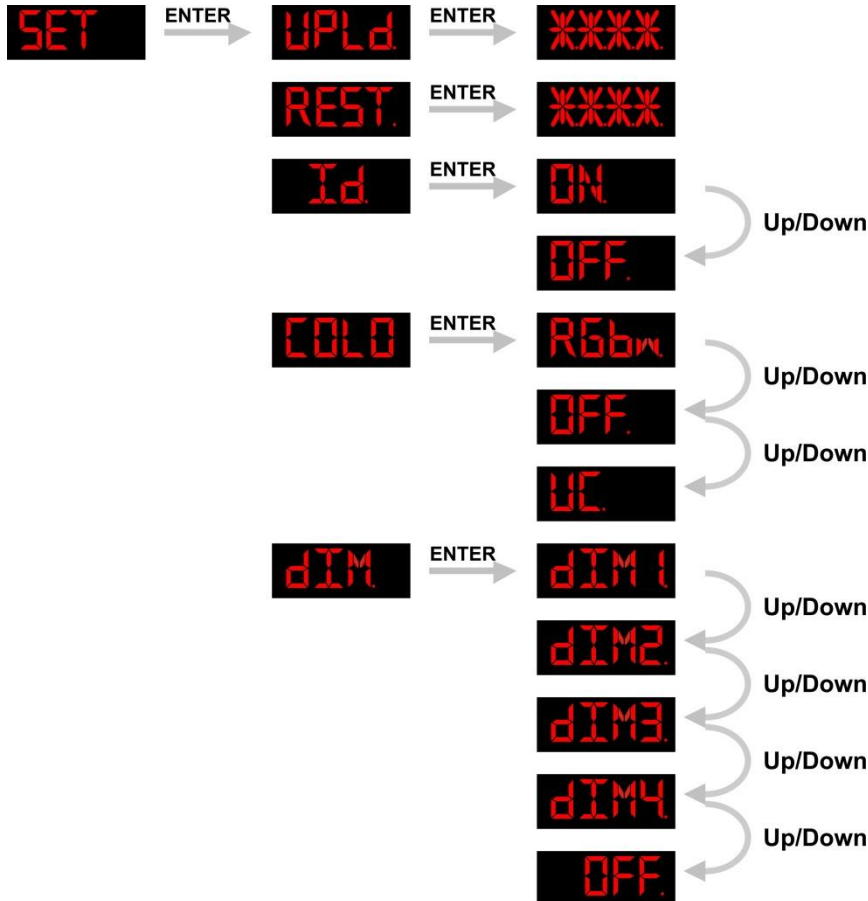

- 1) Enter UPLD to upload the custom programs from the current MASTER device to all SLAVE devices. In order to activate the upload function the password must be entered.

**Password:** UP > DOWN > UP > DOWN. Then press ENTER to confirm your password.

When uploading the MASTER and SLAVE units will light up YELLOW.

If an error occurs when uploading the MASTER and/or SLAVE devices will light up RED.

When uploading one of the custom programs has been successful, the MASTER and SLAVE devices will light up GREEN.

- 2) In order to reset the custom modes to its default values select REST.
- 3) Enter the ID Mode and select On in order to allow ID address function.
- 4) When you have selected **RGBW** to ON, RGB TO WHITE has been set. This means RGB = 255, 255, 255. The color is displayed as you have calibrated the specific color in menu **CAL2 → RGBW**.  
When it is set to **NO**, on RGB = 255,255,255, the RGB values are not adjusted and the output is most powerful. The **RGB**'s parameter can be adjusted in **CAL2**.
- 5) When **UC** is selected, the RGB output is adjusted to a standard preset universal color. This way, different versions of Spectral M800's are color balanced to match each other.
- 6) Enter DIM Mode to select a certain dimmer mode and dimmer speed.  
When DIMMER is set to OFF, then RGBW and the MASTER DIMMER are linear.  
Dim 1/2/3/4 are speed modes of the non linear dimmer. DIM1 is fastest, and DIM4 is slowest.

The DIM setting doesn't have any effect in TOUR mode.

## White Settings

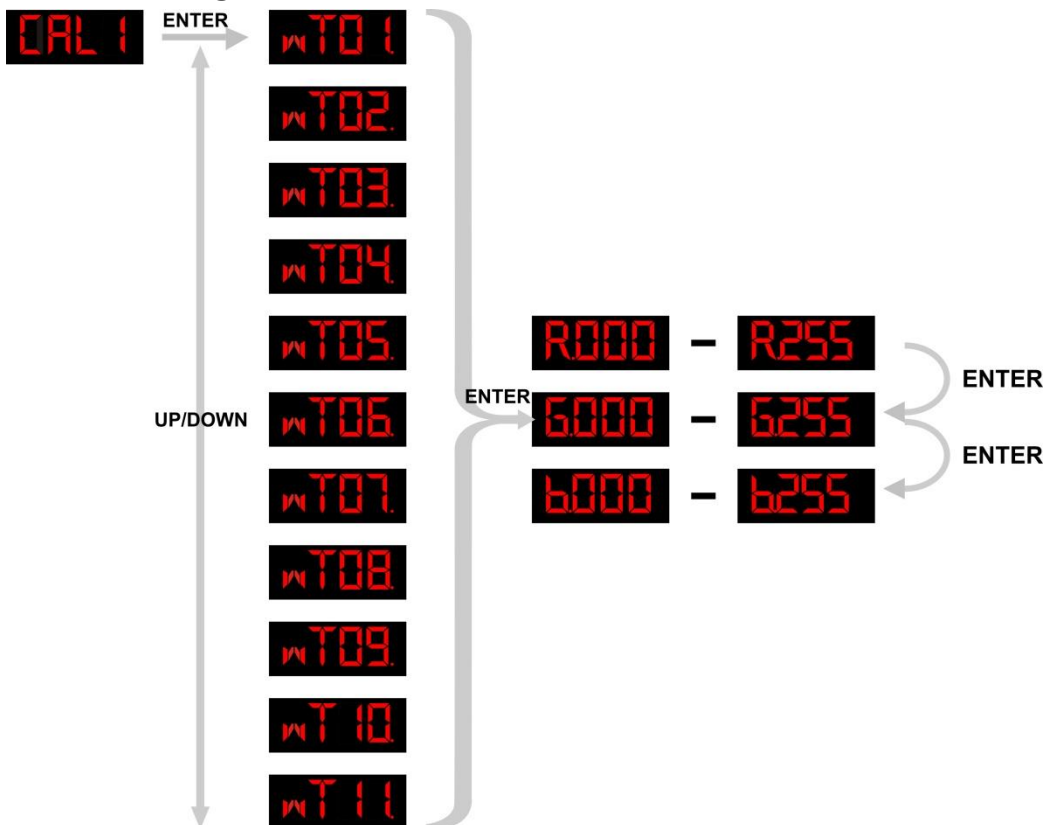

- Enter **CAL1 menu** to select the white colors of a certain color temperature.
- There are 11 pre-programmed White colors that can be edited by using RED, GREEN and BLUE.

## White Balance



- Enter CAL2 to adjust the RGB parameters to create different white color temperatures.
- When the new setting has been activated, the DMX controller chooses RGB = 255,255,255, the white color will be made by the actual RGB values on the **CAL2** Menu.

## Activate Password



- Enter the KEY-LOCK mode to select, whether the access password is On or Off.
- The **Access Password: UP + DOWN + UP + DOWN** .

When you have pressed ENTER in menu KEY ON, it will take 30 seconds before the Spectral M800 is locked.

When the password is activated, the display will ask for password each time the fixture is powered on.

## How to make your own Custom Program

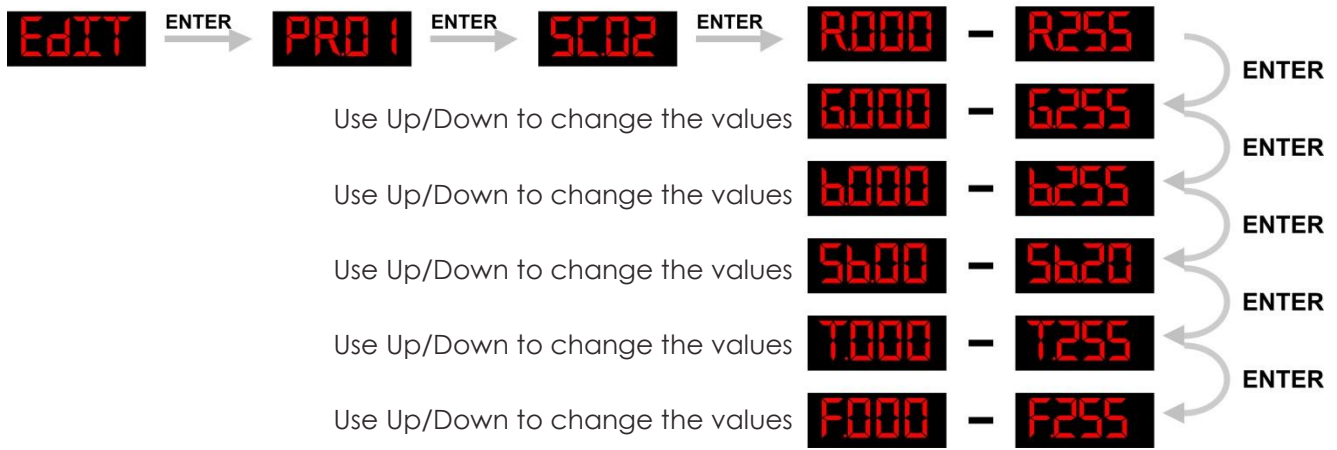
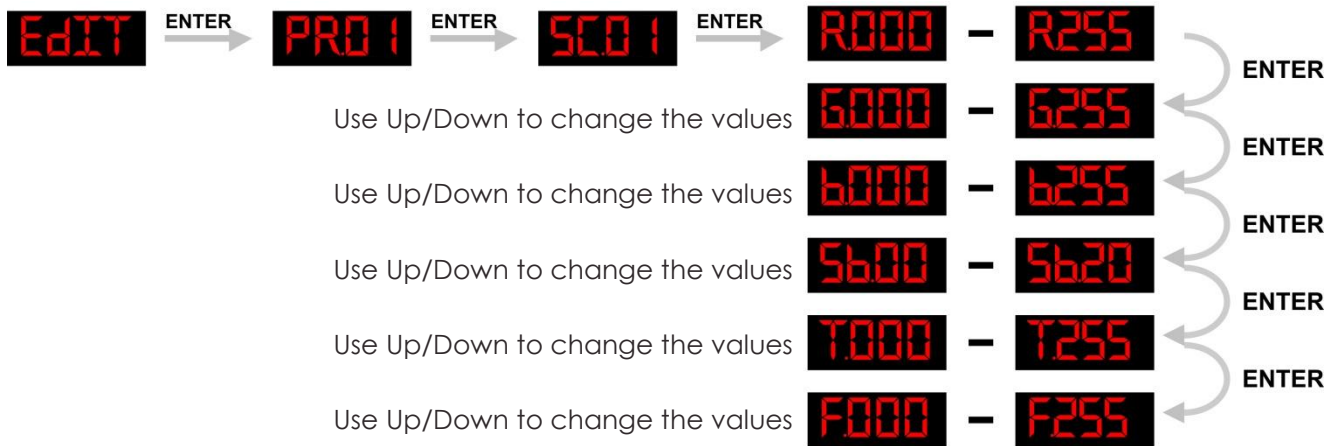

And so you can add a maximum of 30 scenes.

After that you can start with **PR02** and create a maximum of 30 scenes again.

You can repeat these steps, until you've reached PR10, step 30.

This means, it is possible to create 300 separate scenes.

## DMX Control TOUR

| Channel | Value  | Function   |
|---------|--|--|
| 1       | 000 – 255  | <b>Dimmer</b><br>0 – 100 %   |
| 2       | 000 – 255  | <b>Red</b><br>0 – 100 %; <b>CH2</b> will control the <b>TIME</b> , if CH7 is set to custom 01-10 ( <b>only if CH7 121-220</b> )  |
| 3       | 000 – 255  | <b>Green</b><br>0 – 100 %; <b>CH3</b> will control the <b>FADE</b> , if CH7 is set to custom 01-10 ( <b>only if CH7 121-220</b> )  |
| 4       | 000 – 255  | <b>Blue</b><br>0 – 100 %   |
| 5       | 000 – 010<br>011 – 030<br>031 – 050<br>051 – 070<br>071 – 090<br>091 – 110<br>111 – 130<br>131 – 150<br>151 – 170<br>171 – 200<br>201 – 205<br>206 – 210<br>211 – 215<br>216 – 220<br>221 – 225<br>226 – 230<br>231 – 235<br>236 – 240<br>241 – 245<br>246 – 250<br>251 – 255              | <b>Macro Colors</b><br>No Function<br>Red 100% / Green Up / Blue 0%<br>Red Down / Green 100% / Blue 0%<br>Red 0% / Green 100% / Blue Up<br>Red 0% / Green Down / Blue 100%<br>Red Up / Green 0% / Blue 100%<br>Red 100% / Green 0% / Blue Down<br>Red 100% / Green Up / Blue Up<br>Red Down / Green Down / Blue 100%<br>Red 100% / Green 100% / Blue 100%<br>White 1: 3200K<br>White 2: 3400K<br>White 3: 4200K<br>White 4: 4900K<br>White 5: 5600K<br>White 6: 5900K<br>White 7: 6500K<br>White 8: 7200K<br>White 9: 8000K<br>White 10: 8500K<br>White 11: 10000K |
| 6       | 000 – 010<br>011 – 255   | <b>Strobe</b><br>No Function<br>0 – 20 Hz  |
| 7       | 000 – 020<br>021 – 030<br>031 – 040<br>041 – 050<br>051 – 060<br>061 – 070<br>071 – 080<br>081 – 090<br>091 – 100<br>101 – 110<br>111 – 120<br>121 – 130<br>131 – 140<br>141 – 150<br>151 – 160<br>161 – 170<br>171 – 180<br>181 – 190<br>191 – 200<br>201 – 210<br>211 – 220<br>221 – 255 | <b>Auto + Custom</b><br>No Function<br>Auto 1<br>Auto 2<br>Auto 3<br>Auto 4<br>Auto 5<br>Auto 6<br>Auto 7<br>Auto 8<br>Auto 9<br>Auto 10<br>Custom 1<br>Custom 2<br>Custom 3<br>Custom 4<br>Custom 5<br>Custom 6<br>Custom 7<br>Custom 8<br>Custom 9<br>Custom 10<br>No Function   |
| 8       | 000 – 255  | <b>Auto Speed.</b><br><b>CH8</b> will control the <b>AutoSpeed</b> , if CH7 is set to AUTO 1-AUTO 10 ( <b>only if CH7 021-120</b> )  |

|          |   |   |
|----------|---|---|
| <b>9</b> | 000 – 009<br>010 – 069<br>070 – 129<br>130 – 189<br>190 – 255 | <b>Dimmer Speed.</b><br>Linear Dimmer<br>Non Linear Dimmer (fastest) 1<br>Non Linear Dimmer 2<br>Non Linear Dimmer 3<br>Non Linear Dimmer (slowest) 4 |
|----------|---|---|

**Channel 10 (ID address selection)**

|           |          |     |       |     |       |
|-----------|----------|-----|-------|-----|-------|
| 000 – 009 | All ID's | 212 | ID 23 | 235 | ID 46 |
| 010 – 019 | ID 1     | 213 | ID 24 | 236 | ID 47 |
| 020 – 029 | ID 2     | 214 | ID 25 | 237 | ID 48 |
| 030 – 039 | ID 3     | 215 | ID 26 | 238 | ID 49 |
| 040 – 049 | ID 4     | 216 | ID 27 | 239 | ID 50 |
| 050 – 059 | ID 5     | 217 | ID 28 | 240 | ID 51 |
| 060 – 069 | ID 6     | 218 | ID 29 | 241 | ID 52 |
| 070 – 079 | ID 7     | 219 | ID 30 | 242 | ID 53 |
| 080 – 089 | ID 8     | 220 | ID 31 | 243 | ID 54 |
| 090 – 099 | ID 9     | 221 | ID 32 | 244 | ID 55 |
| 100 – 109 | ID 10    | 222 | ID 33 | 245 | ID 56 |
| 110 – 119 | ID 11    | 223 | ID 34 | 246 | ID 57 |
| 120 – 129 | ID 12    | 224 | ID 35 | 247 | ID 58 |
| 130 – 139 | ID 13    | 225 | ID 36 | 248 | ID 59 |
| 140 – 149 | ID 14    | 226 | ID 37 | 249 | ID 60 |
| 150 – 159 | ID 15    | 227 | ID 38 | 250 | ID 61 |
| 160 – 169 | ID 16    | 228 | ID 39 | 251 | ID 62 |
| 170 – 179 | ID 17    | 229 | ID 40 | 252 | ID 63 |
| 180 – 189 | ID 18    | 230 | ID 41 | 253 | ID 64 |
| 190 – 199 | ID 19    | 231 | ID 42 | 254 | ID 65 |
| 200 – 209 | ID 20    | 232 | ID 43 | 255 | ID 66 |
| 210       | ID 21    | 233 | ID 44 |     |       |
| 211       | ID 22    | 234 | ID 45 |     |       |

**MASTER DIMMER**

- CH1 controls the intensity of the currently projected color.
- When the fader is at 255, the intensity of the output is at its maximum.

**RED, GREEN, BLUE & WHITE SELECTION**

- Channels 2, 3 and 4 control the overall intensity of each respective color.
- Channels 2, 3 and 4 can be combined to create an unlimited range of colors.

**COLOR MACROS & WHITE BALANCE**

- Channel 5 selects the required COLOR MACRO and whites in different colors.
- Channel 5 has priority over channels 2, 3 and 4.
- Channel 1 is used to control the intensity of the COLOR MACRO.

**STROBE**

- CH6 is the strobe channel and controls the strobe effects of CH2, CH3, CH4 and CH5.
- The strobe is with an adjustable speed with a maximum of 20Hz.

**ID ADDRESS SELECTION**

- CH10 is used to select the target ID address.
- Each independent DMX address may have up to 66 independent ID addresses.
- ID address "0" allows control of all fixtures simultaneously.

**AUTO**

- Channel 7 selects the preset AUTO and CUSTOM programs (1-10).
- Channel 7 has priority over channels 2, 3, 4, 5 and 6.
- When activating the custom AUTO programs 1-10, it is possible to control the **Step Time (CH2)** and **Fade Time (CH3)**.

**DIMMER SPEED**

Enter DIM Mode (CH9) to select specific dimmer mode and dimmer speed. When DIMMER is set to OFF, then RGB and the MASTER DIMMER are linear. Dim 1/2/3/4 are speed modes of the non linear dimmer. DIM1 is fastest, and DIM4 is slowest.



## DMX Control ARC1

| Channel | Value     | Function                  |
|---------|-----------|---------------------------|
| 1       | 000 – 255 | <b>Red</b><br>0 – 100 %   |
| 2       | 000 – 255 | <b>Green</b><br>0 – 100 % |
| 3       | 000 – 255 | <b>Blue</b><br>0 – 100 %  |

## DMX Control AR1.d

| Channel | Value     | Function                   |
|---------|-----------|----------------------------|
| 1       | 000 – 255 | <b>Dimmer</b><br>0 – 100 % |
| 2       | 000 – 255 | <b>Red</b><br>0 – 100 %    |
| 3       | 000 – 255 | <b>Green</b><br>0 – 100 %  |
| 4       | 000 – 255 | <b>Blue</b><br>0 – 100 %   |

## DMX Control AR1.s

| Channel | Value     | Function                   |
|---------|-----------|----------------------------|
| 1       | 000 – 255 | <b>Dimmer</b><br>0 – 100 % |
| 2       | 000 – 255 | <b>Red</b><br>0 – 100 %    |
| 3       | 000 – 255 | <b>Green</b><br>0 – 100 %  |
| 4       | 000 – 255 | <b>Blue</b><br>0 – 100 %   |
| 5       | 000 – 255 | <b>Strobe</b><br>0 – 100 % |

## DMX Control HSV

| Channel | Value     | Function                                    |
|---------|-----------|---|
| 1       | 000 – 255 | <b>Hue (Color variations)</b><br>0 – 100 %  |
| 2       | 000 – 255 | <b>Saturation of color Red</b><br>0 – 100 % |
| 3       | 000 – 255 | <b>Value (Dimmer)</b><br>0 – 100 %          |

## DMX Value – ID Addresses

| DMX     | ID addresses            |
|---------|-------------------------|
| 0-9     | Select all ID addresses |
| 10-19   | ID address #1           |
| 20-29   | ID address #2           |
| 30-39   | ID address #3           |
| 40-49   | ID address #4           |
| 50-59   | ID address #5           |
| 60-69   | ID address #6           |
| 70-79   | ID address #7           |
| 80-89   | ID address #8           |
| 90-99   | ID address #9           |
| 100-109 | ID address #10          |
| 110-119 | ID address #11          |
| 120-129 | ID address #12          |
| 130-139 | ID address #13          |
| 140-149 | ID address #14          |
| 150-159 | ID address #15          |
| 160-169 | ID address #16          |
| 170-179 | ID address #17          |
| 180-189 | ID address #18          |
| 190-199 | ID address #19          |
| 200-209 | ID address #20          |
| 210     | ID address #21          |
| 211     | ID address #22          |
| 212     | ID address #23          |
| 213     | ID address #24          |
| 214     | ID address #25          |
| 215     | ID address #26          |
| 216     | ID address #27          |
| 217     | ID address #28          |
| 218     | ID address #29          |
| 219     | ID address #30          |
| 220     | ID address #31          |
| 221     | ID address #32          |
| 222     | ID address #33          |

| DMX | ID addresses   |
|-----|----------------|
| 223 | ID address #34 |
| 224 | ID address #35 |
| 225 | ID address #36 |
| 226 | ID address #37 |
| 227 | ID address #38 |
| 228 | ID address #39 |
| 229 | ID address #40 |
| 230 | ID address #41 |
| 231 | ID address #42 |
| 232 | ID address #43 |
| 233 | ID address #44 |
| 234 | ID address #45 |
| 235 | ID address #46 |
| 236 | ID address #47 |
| 237 | ID address #48 |
| 238 | ID address #49 |
| 239 | ID address #50 |
| 240 | ID address #51 |
| 241 | ID address #52 |
| 242 | ID address #53 |
| 243 | ID address #54 |
| 244 | ID address #55 |
| 245 | ID address #56 |
| 246 | ID address #57 |
| 247 | ID address #58 |
| 248 | ID address #59 |
| 249 | ID address #60 |
| 250 | ID address #61 |
| 251 | ID address #62 |
| 252 | ID address #63 |
| 253 | ID address #64 |
| 254 | ID address #65 |
| 255 | ID address #66 |

# Beam Angles

## RED

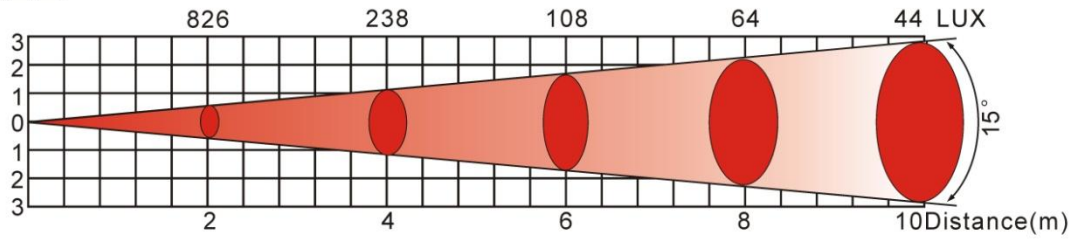

## GREEN

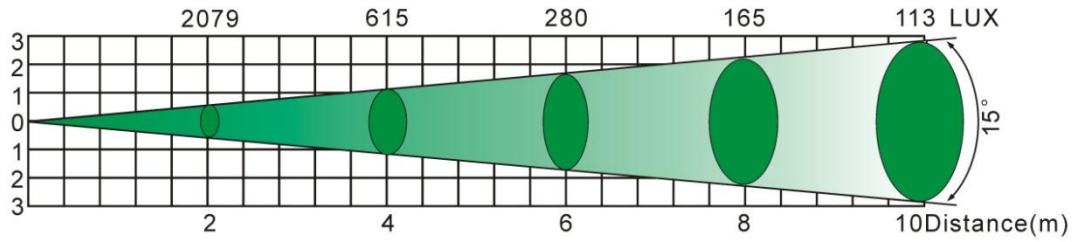

## BLUE

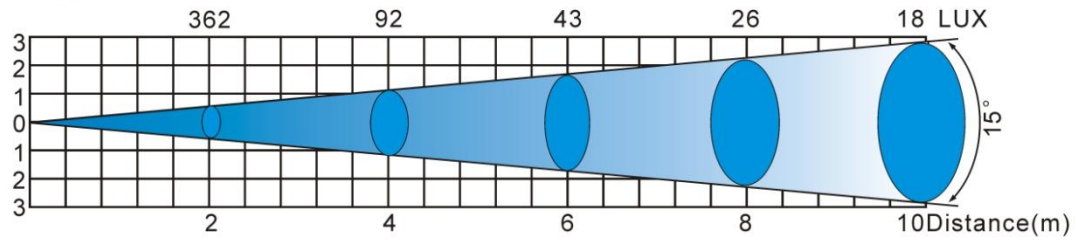

## RGB

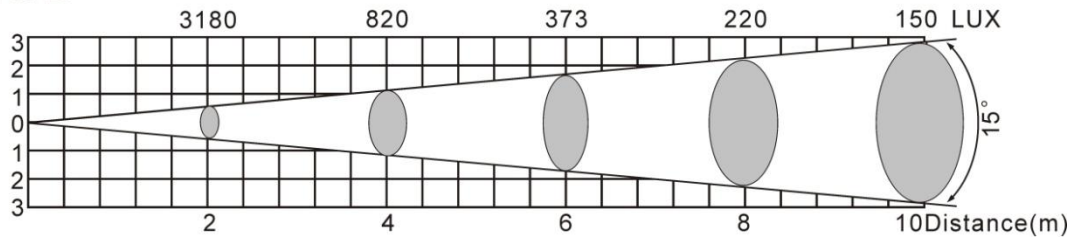

## Connection Cables

Take care of the connector cables, always holding them by the connectors and avoiding knots and twists when coiling them: This gives the advantage of increasing their life and reliability, which is always to your advantage. Periodically check that your cables are in good condition, that they are correctly wired and that all their contacts are perfectly efficient: a great number of problems are caused entirely by using unsuitable or faulty cables.

### Occupation of the XLR-connection:

#### DMX-OUTPUT XLR mounting-socket:



1 - Ground  
2 - Signal (-)  
3 - Signal (+)

#### DMX-input XLR mounting-plug

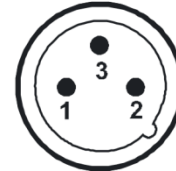

1 - Ground  
2 - Signal (-)  
3 - Signal (+)

### The transformation of the controller line of 3 pins and 5 pins (plug and socket)

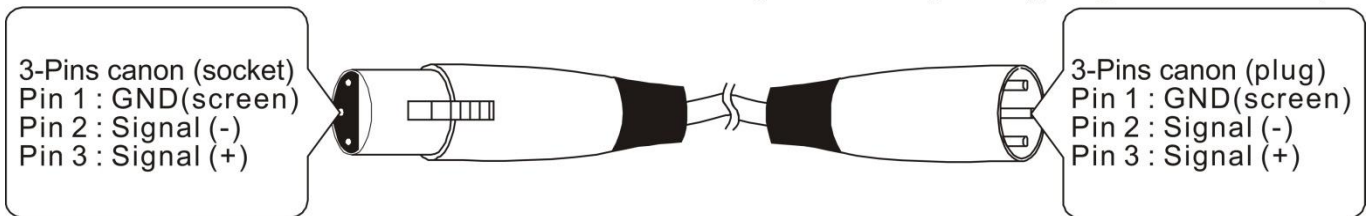

## Maintenance

The Spectral M800 requires almost no maintenance. However, you should keep the unit clean. Otherwise, the fixture's light-output will be significantly reduced. Disconnect the mains power supply and then wipe the cover with a damp cloth. Wipe the front glass panel clean with glass cleaner and a soft cloth. Do not use alcohol or solvents. The front glass panel will require weekly cleaning, as smoke-fluid tends to build up residues, reducing the light-output very quickly. Do not immerse in liquid. Keep connections clean. Disconnect electric power, and then wipe the DMX connections with a damp cloth. Make sure connections are thoroughly dry before linking equipment or supplying electric power.

The operator has to make sure that safety-relating and machine-technical installations are to be inspected by an expert after every year in the course of an acceptance test.

The operator has to make sure that safety-relating and machine-technical installations are to be inspected by a skilled person once a year.

The following points have to be considered during the inspection:

1. All screws used for installing the device or parts of the device have to be tightly connected and must not be corroded.
2. There may not be any deformations on housings, fixations and installation spots.
3. Mechanically moving parts like axles, eyes and others may not show any traces of wearing.
4. The electric power supply cables must not show any damages or material fatigue.

## Troubleshooting

This troubleshooting guide is meant to help solve simple problems.

If a problem occurs, carry out the steps below in sequence until a solution is found. Once the unit operates properly, do not carry out following steps.

1. If the device does not operate properly, unplug the device.
2. Check the power from the wall, all cables etc.
3. If all of the above appears to be O.K., plug the unit in again.
4. If you are unable to determine the cause of the problem, do not open the device, as this may damage the unit and the warranty will become void.
5. Return the device to your Showtec dealer.

## Product Specification

Power Supply: AC 100V-240V, 50/60 Hz  
 Power consumption: 73 Watt  
 Drive current: 350mA  
 Dimensions: 245 x 205 x 245 mm (LxWxH)  
 Weight: 4,6 kg

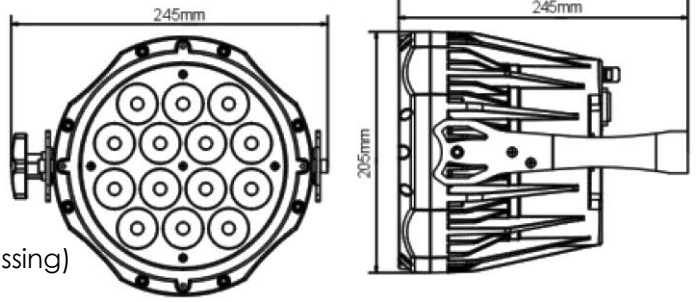

3, 3, 4, 5 or 10-channel LED wash light (with ID addressing)  
 5 different DMX Operating modes  
 RGB colour mixing with or without DMX controller  
 Colour temperature presets (3,200 K ~ 10,000 K)  
 Built-in automated programs via DMX  
 Recall custom programs via DMX  
 14x 3W 3-in-1 RGB LEDs  
 Road-proof housing  
 Available as IP-67 version or Tour version  
 No fans, low noise  
 Max. distance: 25m  
 Colour Range: 16.7 million additive RGB colours  
 Power consumption: 73W max. at full output  
 On-board: Display for Auto and Custom control  
 Control protocol: DMX 512  
 Control personality: TOUR, ARC1, AR1.d, AR1.s, HSV  
 Dimmer: 0-100%  
 Strobe: 0-20Hz  
 Housing: Die-cast aluminium, powder-coated finish  
 Lens plate: Tempered glass  
 Cooling: Convection  
 Ingress Protection: IP67; suitable for indoor and outdoor applications  
 LED display with lock-out feature  
 Beam angle: 16°  
 Lux: 1600+ @ 2m  
 Lumen: 800+  
 Efficiency: 16.30 lm/W (RGB full on)  
 Double-bracket yoke doubles as floor stand

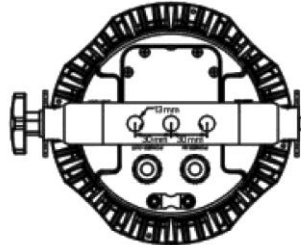

**Operating modes:** 10-channel (**TOUR**): Master Dimmer, RGB, Color Macro, Strobe, Auto & Custom Programs, Auto Speed Adjustment, Dimmer Speed, ID Address Selection  
 3-channel (**ARC.1**): RGB  
 4-channel (**AR1.d**): Master Dimmer, RGB  
 5-channel (**AR1.s**): Master Dimmer, RGB, Strobe  
 3-channel (**HSV**): Hue, Saturation, Value

### Additional Features

LCD display with password protection  
 Double-bracket yoke doubles as floor stand

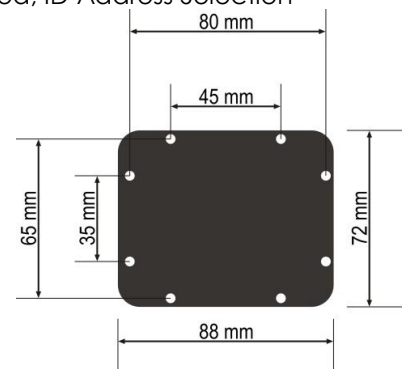

### LUX Values

|              | 2m.  | 4m. | 6m. | 8m. | 10m. |
|--------------|------|-----|-----|-----|------|
| <b>Red</b>   | 826  | 238 | 108 | 64  | 44   |
| <b>Green</b> | 2079 | 615 | 280 | 165 | 113  |
| <b>Blue</b>  | 362  | 92  | 43  | 26  | 18   |
| <b>RGB</b>   | 3180 | 820 | 373 | 220 | 150  |

Design and product specifications are subject to change without prior notice.



Website: [www.Showtec.info](http://www.Showtec.info)

Email: [service@highlite.nl](mailto:service@highlite.nl)



© 2010 Showtec.